



Simply connecting the  world

AT-FS238a / 1
AT-FS238b / 1
AT-FS238a / 2
AT-FS238b / 2

Bridging Converters

Installation Guide

Copyright © 2003 Allied Telesyn, Inc.
960 Stewart Drive, Suite B, Sunnyvale, CA 94085, USA

All rights reserved. No part of this publication may be reproduced without prior written permission from Allied Telesyn, Inc.

Ethernet is a registered trademark of Xerox Corporation. All other product names, company names, logos or other designations mentioned herein are trademarks or registered trademarks of their respective owners.

Allied Telesyn, Inc. reserves the right to make changes in specifications and other information contained in this document without prior written notice. The information provided herein is subject to change without notice. In no event shall Allied Telesyn, Inc. be liable for any incidental, special, indirect, or consequential damages whatsoever, including but not limited to lost profits, arising out of or related to this manual or the information contained herein, even if Allied Telesyn, Inc. has been advised of, known, or should have known, the possibility of such damages.

Electrical Safety and Emission Compliance Statement

Standards: This product meets the following standards.

U.S. Federal Communications Commission

Declaration Of Conformity

Manufacturer Name:	Allied Telesyn, Inc.
Manufacturer Address:	960 Stewart Drive, Suite B Sunnyvale, CA 94085, USA
Manufacturer Telephone:	408-730-0950
Declares that the product:	Bridging Converter
Model Numbers:	AT-FS238a/1, AT-FS238b/1, AT-FS238a/2, AT-FS238b/2

This product complies with FCC Part 15B, Class B Limits:

This device complies with part 15 of the FCC Rules. Operation is subject to the following two conditions: (1) This device must not cause harmful interference, and (2) this device must accept any interference received, including interference that may cause undesired operation.

Radiated Energy

Note: This equipment has been tested and found to comply with the limits for a Class B digital device pursuant to Part 15 of FCC Rules. These limits are designed to provide reasonable protection against harmful interference in a residential installation. This equipment generates, uses and can radiate radio frequency energy and, if not installed and used in accordance with instructions, may cause harmful interference to radio or television reception, which can be determined by turning the equipment off and on. The user is encouraged to try to correct the interference by one or more of the following measures:

- Reorient or relocate the receiving antenna.
- Increase the separation between the equipment and the receiver.
- Connect the equipment into an outlet on a circuit different from that to which the receiver is connected.
- Consult the dealer or an experienced radio/TV technician for help.

Changes and modifications not expressly approved by the manufacturer or registrant of this equipment can void your authority to operate this equipment under Federal Communications Commission rules.

Industry Canada

This Class B digital apparatus meets all requirements of the Canadian Interference-Causing Equipment Regulations.

Cet appareil numérique de la classe B respecte toutes les exigences du Règlement sur le matériel brouilleur du Canada.

RFI Emission

EN55022 Class B  1



Warning: In a domestic environment this product may cause radio interference in which case the user may be required to take adequate measures.  2

Immunity

EN55024  3

Warning: This product requires shielded cables to comply with emission and immunity standards. If it is used with unshielded cables, the user may be required to take measures to correct the interference problem at their own expense.  4

Electrical Safety

EN60950, UL60950  5



Laser

EN60825  6

Warning Class 1 Laser product.  7

Warning Do not stare into the Laser beam.  8

At time of installation, the Fiber Optic Lasers comply with FDA Radiation Performance Standard 21CFR Subchapter J, applicable at date of manufacture.

This is a "Class 1 LED Product" (AT-FS201, AT-FS202 models)  9

Important: Appendix B contains translated safety statements for installing this equipment. When you see the , go to Appendix B for the translated safety statement in your language.

Wichtig: Anhang B enthält übersetzte Sicherheitshinweise für die Installation dieses Geräts. Wenn Sie  sehen, schlagen Sie in Anhang B den übersetzten Sicherheitshinweis in Ihrer Sprache nach.

Vigtigt: Tillæg B indeholder oversatte sikkerhedsadvarsler, der vedrører installation af dette udstyr. Når De ser symbolet , skal De slå op i tillæg B og finde de oversatte sikkerhedsadvarsler i Deres eget sprog.

Belangrijk: Appendix B bevat vertaalde veiligheidsopmerkingen voor het installeren van deze apparatuur. Wanneer u de  ziet, raadpleeg Appendix B voor vertaalde veiligheidsinstructies in uw taal.

Important: L'annexe B contient les instructions de sécurité relatives à l'installation de cet équipement. Lorsque vous voyez le symbole , reportez-vous à l'annexe B pour consulter la traduction de ces instructions dans votre langue.

Tärkeää: Liite B sisältää tämän laitteen asentamiseen liittyvät käännetyt turvaohjeet. Kun näet -symbolin, katso käännettyä turvaohjetta liitteestä B.

Importante: l'Appendice B contiene avvisi di sicurezza tradotti per l'installazione di questa apparecchiatura. Il simbolo , indica di consultare l'Appendice B per l'avviso di sicurezza nella propria lingua.

Viktig: Tillegg B inneholder oversatt sikkerhetsinformasjon for installering av dette utstyret. Når du ser , åpner du til Tillegg B for å finne den oversatte sikkerhetsinformasjonen på ønsket språk.

Importante: O Anexo B contém advertências de segurança traduzidas para instalar este equipamento. Quando vir o símbolo , leia a advertência de segurança traduzida no seu idioma no Anexo B.

Importante: El Apéndice B contiene mensajes de seguridad traducidos para la instalación de este equipo. Cuando vea el símbolo , vaya al Apéndice B para ver el mensaje de seguridad traducido a su idioma.

Obs! Bilaga B innehåller översatta säkerhetsmeddelanden avseende installationen av denna utrustning. När du ser , skall du gå till Bilaga B för att läsa det översatta säkerhetsmeddelandet på ditt språk.

Table of Contents

Electrical Safety and Emission Compliance Statement	iii
Welcome to Allied Telesyn	ix
Where to Find Web-based Guides	ix
Document Conventions	ix
Contacting Allied Telesyn Technical Support	x
Online Support	x
Telephone Support	x
Technical Support E-mail Addresses	x
Returning Products	xi
For Sales or Corporate Information	xi
Tell Us What You Think	xi
Chapter 1	
Overview	1
External Power Supply	4
Key Features	5
Status LEDs	6
Twisted Pair Port	7
Port Speed	7
Duplex Mode	7
Auto MDI/MDI-X	8
Fiber Optic Port	8
Port Speed	8
Duplex Mode	9
Mode Selection Button	9
Link Test	9
MissingLink	9
Smart MissingLink	10
Bridging Converter Performance	10
DIP Switches	11
MAC Address Table	11
Store and Forward	11
Network Topologies	12

Chapter 2

Installing the Bridging Converter 13
Verifying Package Contents 13
Planning the Installation 14
 Selecting a Site 15
Installing the Bridging Converter 16
 Connecting a 12VDC Powered Unit 18
 Wiring and Connecting a 12-50VDC Powered Unit 19
Warranty Registration 23

Chapter 3

Troubleshooting 25

Appendix A

Technical Specifications 27
Physical 27
Environmental 27
Electrical Rating 27
Agency Certifications 28
Fiber Optic Port Specifications 29
RJ-45 Pinout Assignments 30

Appendix B

Translated Safety and Emission Information 33

Welcome to Allied Telesyn

This guide contains instructions on how to install the AT-FS238a/x and AT-FS238b/x Series Bridging Converters.

Where to Find Web-based Guides

The Allied Telesyn web site at **www.alliedtelesyn.com** offers you an easy way to access the most recent documentation, software, and technical information for all of our products. For product guides, select “Support & Services” from our web site.

Document Conventions

This guide uses the following conventions:

Note

Notes provides additional information.



Caution

Cautions indicate that performing or omitting a specific action may result in equipment damage or loss of data.



Warning

Warnings indicates that performing or omitting a specific action may result in bodily injury.

Contacting Allied Telesyn Technical Support

You can contact Allied Telesyn technical support online or by telephone, or e-mail.

Online Support

You can request technical support online by accessing the Knowledge Base at **<http://kb.alliedtelesyn.com>**. You can use the Knowledge Base to submit questions to our technical support staff and review answers to previously asked questions.

Telephone Support

For Technical Support by telephone, contact Allied Telesyn at one of the following locations:

Americas

United States, Canada, Mexico,
Central America, South America
Tel: 1 (800) 428-4835

Germany

Switzerland, Austria, Eastern Europe
Tel: (+49) 30-435-900-126

Asia

Singapore, Taiwan, Thailand,
Malaysia, Indonesia, Korea,
Philippines, China, India, Hong Kong
Tel: (+65) 6381-5612

Italy

Spain, Portugal, Greece, Turkey, Israel
Tel: (+39) 02-41-30-41

Australia

Tel: 1 (800) 000-880

Japan

Tel: (+81) 3-3443-5640

France

Belgium, Luxembourg, The
Netherlands, Middle East, Africa
Tel: (+33) 0-1-60-92-15-25

United Kingdom

Denmark, Norway, Sweden, Finland,
Iceland
Tel: (+0044) 1235-442500

Technical Support E-mail Addresses

Latin America, Mexico, Puerto Rico, Caribbean, and Virgin Islands
latin_america@alliedtelesyn.com

United Kingdom, Sweden, Norway, Denmark, and Finland
europa_support@alliedtelesyn.com

Returning Products

Products for return or repair must first be assigned a Return Materials Authorization (RMA) number. A product sent to Allied Telesyn without a RMA number will be returned to the sender at the sender's expense.

To obtain an RMA number, contact Allied Telesyn's Technical Support at one of the following locations:

North America

Toll-free: 1-800-762-1664

Fax: 1-425-806-1050

Europe, Africa, and the Middle East

Tel: +44-1793-501401

Fax: +44-1793-431099

Latin America, the Caribbean, Virgin Islands

Tel: international code + 425-481-3852

Fax: international code + 425-481-3895

Asia and Southeast Asia

Tel: +65-6381-5612

Fax: +65-6383-3830

Mexico

Toll-free: 1-800-424-5012, ext 3852

Fax: international code + 425-481-3895

Puerto Rico

Toll-free: 1-800-424-5012, ext 3852

or 1-800-424-4284, ext 3852

Australia

Toll-free: 1-800-000-880

Fax: + 61-2-9438-4966

New Zealand

Toll-free: 0800-45-5782

Fax: +65-383-3830

For Sales or Corporate Information

You can contact Allied Telesyn for sales or corporate information at the location below:

Allied Telesyn, Inc.

19800 North Creek Parkway, Suite 200

Bothell, WA 98011

Tel: 1 (425) 487-8880

Fax: 1 (425) 489-9191

Tell Us What You Think

If you have any comments or suggestions on how we might improve this or other Allied Telesyn documents, please fill out the General Enquiry Form online. This form can be accessed by selecting "Contact Us" from www.alliedtelesyn.com.

Chapter 1

Overview

The AT-FS238a/x and AT-FS238b/x Series Bridging Converters are the 10/100Mbps fast switch single-mode fiber transceivers which can send and receive on two different wavelengths (1310nm and 1550nm) on a single-mode fiber cable.

The AT-FS238a/x and AT-FS238b/x Series Bridging Converters include the following models:

- AT-FS238a/1
- AT-FS238b/1
- AT-FS238a/2
- AT-FS238b/2

Below is how to differentiate between the models mentioned above:

- AT-FS238a/1 = (1310TX/1550RX) - 15 km range
- AT-FS238b/1 = (1550TX/1310RX) - 15 km range
- AT-FS238a/2 = (1310TX/1550RX) - 40 km range
- AT-FS238b/2 = (1550TX/1310RX) - 40 km range

The AT-FS238a/x and AT-FS238b/x Series Bridging Converters are designed to extend the distance of your network by converting Fast Ethernet data between twisted pair cabling and single-mode fiber optic cabling. These dual-port bridging converters can also be used to improve the performance of your network by dividing it into smaller, more manageable segments.

Each bridging converter features a 100Base-FX fiber optic port and a 10Base-T/100Base-TX twisted pair port. The fiber optic port has a simplex SC (Subscriber Connector) connector and an operating distance of 15 kilometers (9.4 miles) or 40 kilometers (24.8 miles), depending on the model. The twisted pair port has an RJ-45 connector with a maximum operating distance of 100 meters (328 feet).

The fiber optic port operates at 100 Mbps, while the twisted pair port operates at 10 Mbps or 100 Mbps. Both ports feature half- and full-duplex operation.

AT-FS238a/x and AT-FS238b/x Series Bridging Converters can be installed on a desktop or in an AT-MCR12 chassis. These bridging converters are easy to install and do not require software configuration or management.

Note

The AT-FS238a/x and AT-FS238b/x Series Bridging Converters are designed to be used in pairs; therefore, the AT-FS238a/x fiber port must be connected to the AT-FS238b/x fiber port only.

Figure 1 illustrates the front panel of the AT-FS238a/x Series Bridging Converter.

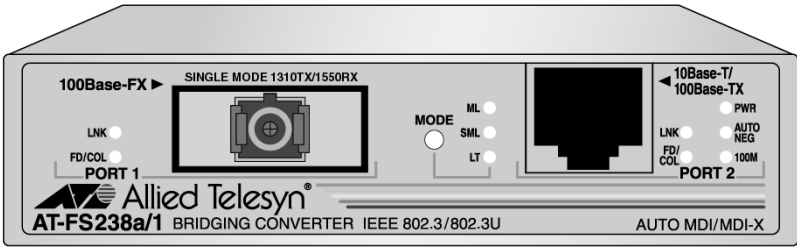

Figure 1 AT-FS238a/x Series Front Panel (AT-FS238a/1 Model)

Figure 2 illustrates the front panel of the AT-FS238b/x Series Bridging Converter.

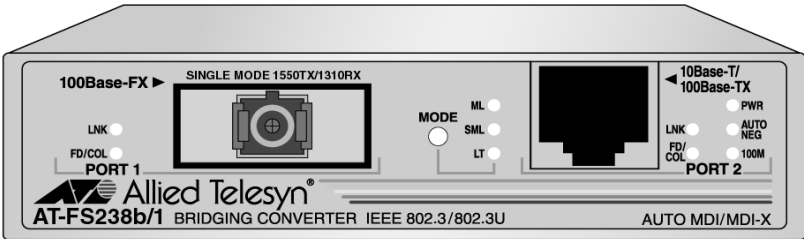

Figure 2 AT-FS238b/x Series Front Panel (AT-FS238b/1 Model)

The back panel of the AT-FS238a/x and AT-FS238b/x Series Bridging Converters features a receptacle power connector and DIP switches for manually configuring the ports.

Note

The AT-FS238a/x and AT-FS238b/x Bridging Converters are designed with 2 different receptacle connectors: 12VDC only or 12-50VDC version models.

Figure 3 illustrates the back panel of the AT-FS238a/x or the AT-FS238b/x Series Bridging Converters with 3-prong receptacle connector for the 12VDC version model.

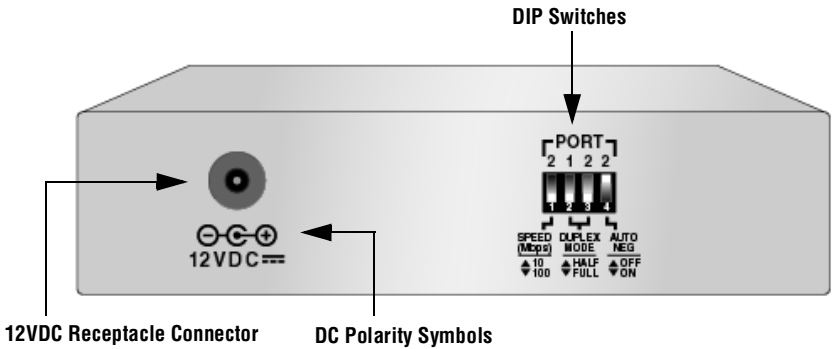

Figure 3 Back Panel of the AT-FS238a/x and AT-FS238b/x Series Bridging Converters (12VDC Receptacle Connector)

Figure 4 illustrates the back panel of the AT-FS238a/x and the AT-FS238b/x Series Bridging Converters with the 3-prong receptacle connector for the 12-50VDC version model.

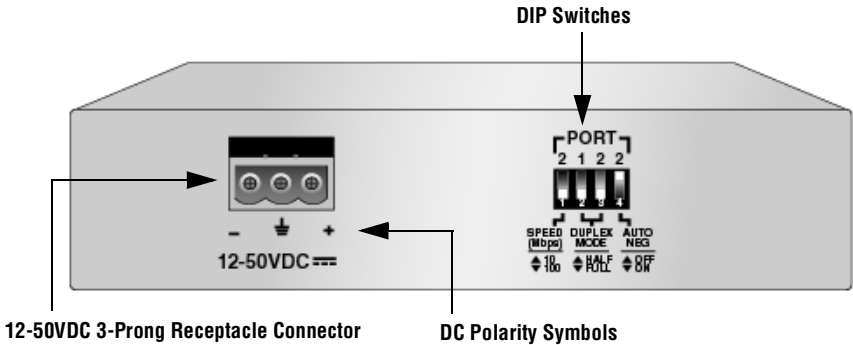

Figure 4 Back Panel of the AT-FS238a/x and AT-FS238b/x Series Bridging Converters (12-50VDC 3-Prong Receptacle Connector)

Table 1 lists the maximum operating distances for the bridging converters.

Table 1 Maximum Operating Distances

Model	100Base-FX		10Base-T/100Base-TX	
	Connector	Maximum Operating Distance ¹	Connector	Maximum Operating Distance ²
AT-FS238a/1 AT-FS238b/1	SC	15 km (9.3 mi)	RJ-45	100 m (328 ft)
AT-FS238a/2 AT-FS238b/2	SC	40 km (24.8 mi)	RJ-45	100 m (328 ft)

1. Maximum distance for 100 Mbps optical datalinks is dependent on the following factors: type of optical fiber, duplex mode of both end-nodes, and maximum optical loss budget for each of the optical fiber at the operating optical wavelength.
2. Maximum distance can only be obtained when the UTP/STP cabling is installed and verified to TIA/EIA 568A Commercial Building Telecommunications Cabling Standard.

External Power Supply

The AT-FS238a/x and AT-FS238b/x Series Bridging Converters are designed with either the 12VDC or the 12-50VDC receptacle power connector.

Any of the following power sources can be used with the AT-FS238a/x or AT-FS238b/x Series Bridging converter.

- An AC/DC power adapter - used specifically with the 12VDC-rated version model
- An AT-PWR237 power adapter (12V or 15V output) - used with the 12-50VDC-rated version model. This power adapter must be used with the power connector provided, shown in Figure 5 on page 5.
- A regulated power supply (SELV power source per IEC 60950) - rated minimum 12-50VDC 0.5A - used specifically with the 12-50VDC-rated version model. This power supply must be used with the power connector provided, shown in Figure 5 on page 5.

Note

Use only power sources that are UL Listed (QGGQ or EPBU), TUV Licensed, or other Safety Agencies approved, suitable for country of use.

Figure 5 illustrates the power connector provided with the unit.



Figure 5 Power Connector for the 12-50VDC Version Converter

Key Features

The AT-FS238a/x and AT-FS238b/x Series Bridging Converters have the following features:

- LEDs for unit and port status
- Auto MDI/MDI-X
- Mode selection button that toggles between Link Test, MissingLink™, and Smart MissingLink
- DIP switches for configuring the ports
- Half- or full-duplex operation on both ports
- RJ-45 twisted pair connector
- SC fiber optic connector
- Data packet forwarding and filtering at full wire speed (10 Mbps to 100 Mbps, and 100 Mbps to 100 Mbps)
- Store and forward switching mode
- Automatic address learning and aging
- IEEE 802.3u compliant auto-negotiation
- External power adapter (depending on the model)
- For use on a desktop or in an AT-MCR12 chassis

Status LEDs

Table 2 defines the LEDs for the bridging converters.

Table 2 Status LEDs

LED	Color	Description
PWR	Green	Power is applied to the unit.
AUTO NEG	Green OFF	Auto-negotiation on the twisted pair port is enabled. Auto-negotiation on the twisted pair port is disabled.
100M	Green OFF	The twisted pair port is operating at 100 Mbps. The twisted pair port is operating at 10 Mbps.
LNK	Green Blinking	A valid link has been established on the port. Data is being received or transmitted on the port.
FD/COL	Green OFF Blinking	The bridging converter is operating in full-duplex mode. The bridging converter is operating in half-duplex mode. A collision has been detected on the port.
Mode Status		
ML	Green	MissingLink is enabled.
SML	Green	Smart MissingLink is enabled.
LT	Green	Link Test is enabled.

Twisted Pair Port

The AT-FS238a/x and AT-FS238b/x Series Bridging Converters have one 10Base-T/100Base-TX twisted pair port. The twisted pair port features a RJ-45 connector.

Port Speed

The twisted pair port is compliant with the 10Base-T and 100Base-TX standards and is capable of either 10 Mbps or 100 Mbps operation. You can set the port speed manually or, since the port is IEEE 802.3u auto-negotiation compliant, you can allow the bridging converter to set the port speed automatically. With auto-negotiation, the speed of the port is set automatically by the bridging converter after it determines the speed of the end-node connected to the port. Auto-negotiation is designed to ensure that the port on the bridging converter and the end-node are operating at the same speed and that they are communicating at the highest possible common speed of the devices.

Duplex Mode

Duplex mode refers to how an end-node receives and transmits data. If an end-node can receive or transmit data, but not both simultaneously, the end-node is operating in what is referred to as half-duplex mode. If an end-node can both receive and transmit data simultaneously, the end-node is said to be operating in full-duplex mode. Naturally, an end-node capable of operating in full-duplex can handle data much faster than an end-node that can only operate in half-duplex mode.

The twisted pair ports on the AT-FS238a/x and AT-FS238b/x Series Bridging Converter can operate in either half-or full-duplex mode. They are IEEE 802.3u-compliant and use Auto-Negotiation to set the duplex mode setting for you automatically.

For Auto-Negotiation to operate properly on a bridging converter, the end-nodes connected to the converter should also use Auto-Negotiation. If an end-node does not have this feature and has a fixed duplex mode of full-duplex, the result will be a duplex mode mismatch between the end-node and a converter port. A port on the bridging converter connected to an end-node with a fixed duplex mode of full-duplex will operate at only half-duplex. This results in the end node using full-duplex and the switch port using half-duplex. This can produce network performance problems. Should you encounter this situation, you must configure the port on the end-node to use Auto-Negotiation or, if it lacks that feature, to half-duplex.

Auto MDI/MDI-X

An RJ-45 twisted pair port on a 10 Mbps or 100 Mbps Ethernet network device can have one of two possible wiring configurations: MDI or MDI-X. The RJ-45 port on a PC, router, or bridge is typically wired as MDI, while the twisted pair port on a bridging converter or hub is usually MDI-X.

To connect two 10 Mbps or 100 Mbps network devices together that have dissimilar port wiring configurations, such as MDI to MDI-X, you would usually use a straight-through twisted pair cable. To connect two network devices that have the same wiring configuration, such as MDI to MDI, you would usually use a crossover cable.

The AT-FS238a/x and AT-FS238b/x Series Bridging Converters feature automatic MDI/MDI-X. The RJ-45 port automatically determines the configuration of the port on the device to which it is connected and then configures itself appropriately. For example, if a port on a bridging converter is connected to a port on a bridge, which is typically wired as MDI, the port on the bridging converter automatically configures itself as MDI-X. This feature allows you to use either crossover cables or straight-through cable when connecting a device to the twisted pair port.

Fiber Optic Port

The AT-FS238a/x and AT-FS238b/x Series Bridging Converters have one 100Base-FX fiber optic port. The single-mode fiber optic port features a simplex SC connector.

Port Speed

The fiber optic port is compliant with the 100Base-FX standard and has a fixed operating speed of 100 Mbps. The end-node connected to the fiber optic port on the bridging converter must also be able to operate at 100 Mbps. The AT-FS238a/x and AT-FS238b/x Series Bridging Converters can send and receive on the two different wavelengths (1310nm and 1550nm). The different wavelengths used by these bridging converters are as follow:

- AT-FS238a/x - TX=1310 and RX=1550
- AT-FS238b/x - TX=1550 and RX=1310

Note

The AT-FS238a/x and AT-FS238b/x Series Bridging Converters are designed to be used in pairs; therefore, the AT-FS238a/x fiber must be connected to the AT-FS238b/x fiber only.

Duplex Mode

The fiber optic port on the bridging converter can operate in half- or full-duplex mode. You must set the duplex mode manually using the DIP switches on the back of the unit.

Mode Selection Button

Link Test

The link test is a fast and easy way for you to test the connections between the bridging converter ports and the end-nodes that are connected to the ports. If a network problem occurs, you can perform a link test to determine which port is experiencing a problem, and be able to focus your troubleshooting efforts on the cable and end-node where the problem resides.

A link test is performed when the Mode Selection button is toggled until the LNK LED is green.

Note

Performing a link test does not interfere with a bridging converter's ability to pass network traffic.

MissingLink

The MissingLink feature enables the fiber optic ports on the bridging converter to pass the "Link" status of their connections to each other. When the bridging converter detects a problem with one of the ports, such as the loss of connection to an end-node, the bridging converter shuts down the connection to the other port, thus notifying the end-node that the connection has been lost.

For example, if the network twisted pair cable to the 10Base-T/100Base-TX port on the bridging converter were to fail, the unit would respond by dropping the link on the 100Base-FX fiber optic port. In this way, the bridging converter notifies the end-node connected to the fiber optic port that the connection on the twisted pair port has been lost. If the failure had started with the fiber optic cabling, the unit would drop the link to the twisted pair port.

The value to this type of network monitoring and fault notification is that some devices can be configured to take a specific action in the event of the loss of connection on a port. In some cases, the unit can be configured to seek a redundant path to a disconnected end-node or send out a trap to a network management station, and so alert the network administrator of the problem.

Note

MissingLink or Smart MissingLink is disabled when you perform a link test. Consequently, to ensure that the MissingLink or Smart MissingLink is enabled on the bridging converter, always set the Mode Selection button so that the ML or SML LED is green during normal network operations.

Smart MissingLink

Like MissingLink, the Smart MissingLink feature terminates the link on the failed port thereby notifying you when a connection has been lost. Additionally, Smart MissingLink indicates on which port the connection has failed. This is shown by a blinking LNK LED on the good port.

For example, if the network twisted pair cable to the 10Base-T/100Base-TX port on the bridging converter were to fail, the LNK LED on the 100Base-FX fiber optic port will blink, indicating a failed connection on the twisted pair port. The fiber optic port is still able to receive a signal.

The bridging converter notifies the end-node connected to the fiber optic port that the connection on the twisted pair port has been lost. If the failure had started with the fiber optic cabling, the LNK LED on the twisted pair port would blink.

The value to this type of network monitoring and fault notification is so that you can quickly see which port has failed and troubleshoot your network accordingly.

Bridging Converter Performance

The bridging converters perform at:

- ❑ 148,800 pps for 100 Mbps and 14,880 pps for 10 Mbps for full wire speed forwarding and filtering
- ❑ 200 Mbps maximum throughput in 100 Mbps, full-duplex mode
- ❑ 20 Mbps maximum throughput in 10 Mbps, full-duplex mode
- ❑ Storage for up to 2k MAC addresses
- ❑ 280 kB (per port) packet buffer
- ❑ Low latency 15.6 μ s (64-byte packet, 100 Mbps full-duplex)

DIP Switches

The DIP switches are used to manually configure the operating characteristics of the ports. These characteristics include the port speed, duplex mode, and auto-negotiation.

On the 100Base-FX fiber optic port, you can manually set the duplex mode to either half- or full-duplex.

On the 10Base-T/100Base-TX twisted pair port, you can manually set the speed of the port to either 10 Mbps or 100 Mbps, set the duplex mode to either half- or full-duplex and enable or disable auto-negotiation. Enabling auto-negotiation will automatically set the port's speed and duplex mode.

MAC Address Table

Up to 2,000 MAC addresses can be stored in the bridging converter's MAC address table. The bridging converter's self-learning feature will learn all new addresses in real-time after power-up. If the source address of an incoming packet is not found in the MAC address table, the bridging converter will update the table with the new address.

The bridging converter also has an automatic address aging feature that will delete a source address from the table if it has not seen a frame from the end-node with that address within five minutes. This prevents the table from becoming filled with addresses of end-nodes that are no longer active.

The bridging converter forwards all multicast, broadcast, and unicast packets when the MAC address table has exceeded its storage limit.

Store and Forward

The AT-FS238a/x and AT-FS238b/x Series Bridging Converters support store and forward switching at Fast Ethernet full-wire speed in 100 Mbps, half- or full-duplex mode. Packets entering each port are stored in buffers. Once the full packet is received, the bridging converter will forward or discard the packet, depending on its destination address and error status. This ensures that only error-free packets destined for another segment will be transferred across the bridging converter, reducing network load. For example, if the packet entering from Port 1 is destined for an end-node on Port 2, the bridging converter forwards the frame if the frame does not contain any errors. If the packet from Port 1 is destined for an end-node also connected to Port 1, the packet is discarded.

The bridging converter will discard CRC errors, misaligned, runt, and oversized packets. When the packet has dribble bits at the end, the bridging converter will truncate to octet boundary and check for a good FCS before forwarding.

Network Topologies

Figure 6 illustrates a back-to-back topology using one AT-FS238a/x and one AT-FS238b/x Series Bridging Converters to interconnect two small networks of stackable hubs.

- ❑ Network 1 has an AT-FS709FC connected to the 100Base-TX port on the AT-FS238a/x Series Bridging Converter.
- ❑ Network 2 has an AT-8024 switch connected to the 10Base-T/100Base-TX port on the AT-FS238b/x Series Bridging Converter.

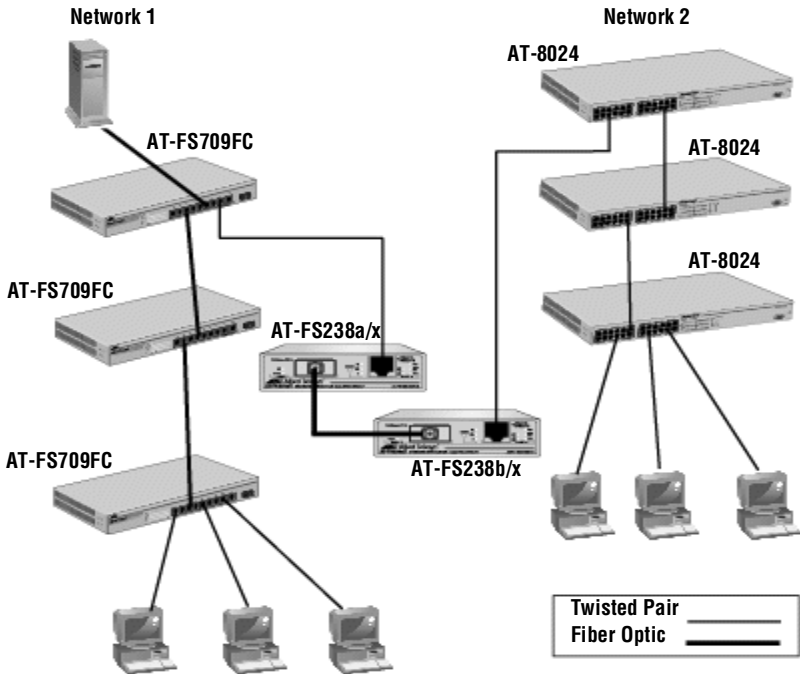

Figure 6 Network Topology

Chapter 2

Installing the Bridging Converter

This chapter explains how to install an AT-FS238a/x and AT-FS238b/x Series Bridging Converters. These bridging converters can be installed on a desktop or in an AT-MCR12 chassis.

Verifying Package Contents

Make sure the following items are included in your package. If any item is missing or damaged, contact your Allied Telesyn sales representative for assistance.

- One AT-FS238a/x or AT-FS238b/x Series Bridging Converter
- Four protective feet (for desktop use only)
- Optional power supply (depending on the model)
- Optional power connector
- This installation guide
- Warranty card

Note

For information on the power supplies used with the AT-FS238a/x or AT-FS238b/x Series Bridging Converter, refer to “External Power Supply” on page 3.

Planning the Installation

Be sure to observe the following guidelines when planning the installation of your bridging converter.

- ❑ The AT-FS238a/x and AT-FS238b/x Series Bridging Converters must be connected back-to-back; therefore, one AT-FS238a/x and one AT-FS238b/x Series converters are required.
- ❑ The end-node connected to the 10Base-T/100Base-TX twisted pair port can operate at either 10 Mbps or 100 Mbps.
- ❑ The end-node connected to the twisted pair port on the bridging converter can be a network adapter card, repeater, router, hub, or another bridging converter.
- ❑ The twisted pair cabling must be kept away from sources of electrical noise, such as radios, transmitters, power lines, broadband amplifiers, electrical motor, and fluorescent fixtures.
- ❑ Refer to Table 3 for the cabling specifications for the twisted pair port.

Table 3 10Base-T/100Base-TX Twisted Pair Cabling Specifications

Operating Mode	Cable Type	Maximum Operating Distance
10Base-T	Shielded or unshielded Category 3 or better	100 m (328 ft)
100Base-TX	Shielded or unshielded Category 5 or better	100 m (328 ft)

- Refer to Table 4 for the cabling specifications for the fiber optic port operating in full-duplex mode.

Table 4 100Base-FX Fiber Optic Cabling Specifications (Full-duplex)

Model	Cable Type	Maximum Operating Distance ¹	Maximum Allowable Loss Budget
AT-FS238a/1	9/125 micron SMF Simplex	15 km (9.3 mi)	6 dB at 1310 nm
AT-FS238b/1	9/125 micron SMF Simplex	15 km (9.3 mi)	6 dB at 1310 nm
AT-FS238a/2	9/125 micron SMF Simplex	40 km (24.8 mi)	16 dB at 1310 nm
AT-FS238b/2	9/125 micron SMF Simplex	40 km (24.8 mi)	16 dB at 1310 nm

1. Maximum distance for 100 Mbps optical datalinks is dependent on the following factors: quality of fiber optic, duplex mode of both end-nodes, and maximum optical loss budget for the optical fiber at each optical wavelength.

Note

Refer to “Fiber Optic Port Specifications” on page 29 for additional information on the fiber optic port.

Selecting a Site

Be sure to observe the following guidelines when selecting a site for your bridging converter.

- Select a site that is dust-free and moisture-free.
- Select a site that will allow you to easily access the data cables and power cord.
- Use dedicated power circuits or power conditioners to supply reliable power to the device.
- Use the power sources as described in “External Power Supply” on page 3.
- For 12-50VDC version, provide regulated DC power only from SELV sources per IEC 60950, such as regulated power supplies.

Note

Use only power sources that are UL Listed (QGGQ or EPBU), TUV Licensed or other Safety Agencies approved, suitable for country of use.

Installing the Bridging Converter

To install an AT-FS238a/x or an AT-FS238b/x Series Bridging Converter, perform the following procedures:

1. Remove all equipment from the package and store the packaging material in a safe place.

Note

Do not remove the dust cover from the fiber optic port until you are ready to connect the fiber optic cable. Dust contamination can adversely impact the operating performance of the port and the bridging converter.

2. Attach the four protective feet (provided) to each corner of the bottom of the unit. Refer to Figure 7. **Do not attach the protective feet if you are installing the bridging converter in an AT-MCR12 chassis.**

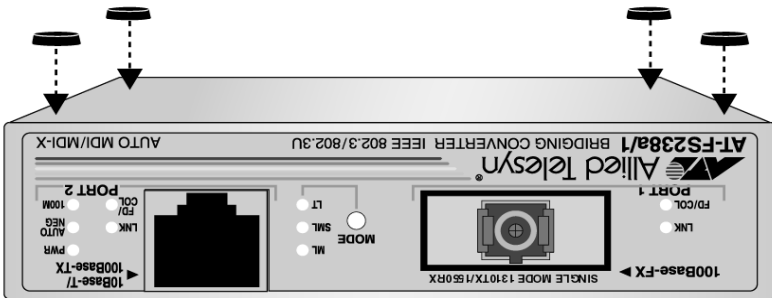

Figure 7 Attaching the Protective Feet

3. Configure the DIP switches. Refer to Figure 2 on page 2 for the location of the DIP switches and Table 5 on page 17 for the possible settings.

Note

Changing the DIP switch settings are effective after resetting the unit. To reset the unit, power the unit OFF then ON.

Table 5 DIP Switch Settings

DIP Switch Number	Port	Setting	Position	Description
1	2	Speed (Mbps)	Up	The twisted pair port is operating at 10 Mbps.
			Down	The twisted pair port is operating at 100 Mbps.
2	1	Duplex Mode	Up	The fiber optic port is operating at half-duplex mode.
			Down	The fiber optic is operating at full-duplex mode.
3	2	Duplex Mode	Up	The twisted pair port is operating at half-duplex mode.
			Down	The twisted pair port is operating at full-duplex mode.
4	2	Auto Neg	Up	Auto-negotiation on the twisted pair port is OFF.
			Down	Auto-negotiation on the twisted pair port is ON.

When setting the DIP switches, consider the following:

- Setting the Auto Neg DIP switch for the twisted pair port to ON or OFF enables or disables auto-negotiation for the port. If you disable auto-negotiation, be sure to set the DIP switches for the port's speed and duplex mode to match the speed and duplex mode of the end-node.
 - For the fiber optic port, set the port's duplex mode using the appropriate Duplex Mode DIP switch. This setting must match the duplex mode capability of the end-node to be connected to the port.
4. If you are installing the bridging converter in an AT-MCR12 chassis, download the *AT-MCR12 Chassis Installation Guide* from our web site for instructions on how to install the bridging converter, then proceed to Step 7.

5. Place the bridging converter on a secure, level surface, leaving ample space around the bridging converter for ventilation.
6. Plug the power adapter into an appropriate AC power outlet and insert the power plug into the DC receptacle located on the back of the bridging converter.

For instructions how to connect an 12VDC Powered AT-FS238a/x or AT-FS238b/x Series Bridging Converter, refer to “Connecting a 12VDC Powered Unit” on page 18.

For instructions how to wire to an 12-50VDC Powered AT-FS238a/x or AT-FS238b/x Series Bridging Converter, refer to “Wiring and Connecting a 12-50VDC Powered Unit” on page 19.

Note

This step does not apply if you are mounting the bridging converter in an AT-MCR12 chassis.

7. Remove the dust cover from the fiber optic port and connect the fiber optic cable to the 100Base-FX port.
8. Connect the twisted pair cable to the 10Base-T/100Base-TX port.
9. Power ON the end-nodes.
10. Verify that the LNK LEDs for both the fiber optic port and the twisted pair port are green. If either LED is OFF, refer to “Troubleshooting” on page 25 for instructions.

The bridging converter runs a series of self-diagnostic tests. Once the self tests are complete, the converter is ready for normal network operations.

Connecting a 12VDC Powered Unit

For the 12VDC version bridging converter using an approved safety compliant AC power adapter, perform the following steps:

Note

This power adapter is not used if you install the bridging converter in an AT-MCR12 chassis.

1. Plug one end of the DC power cord to the power receptacle connector labelled 12VDC on the back panel of the bridging converter, as shown in Figure 8. Plug the AC/DC power adapter to a power outlet. (Refer to “**Technical Specifications**” on page 27 for power requirements.)

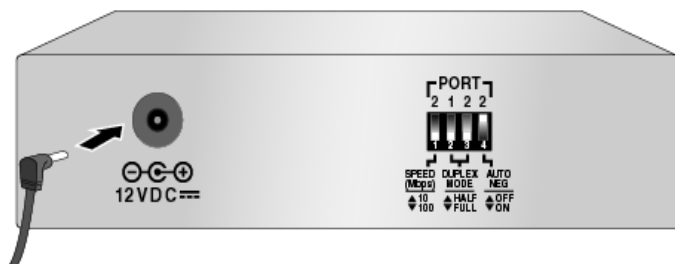

Figure 8 Connecting an 12VDC Powered Unit

2. Verify that the PWR LED on the front of the unit is green. If the PWR LED is OFF, refer to “Troubleshooting” on page 25.

Wiring and Connecting a 12-50VDC Powered Unit

To wire a 12-50VDC powered unit, perform the following step:

1. Before attaching wires to the DC terminal block on the DC power supply, review the following Warning statements:



Warning

Only trained and qualified personnel are allowed to install or to replace this equipment.



Warning

For 12-50VDC power connection, install this equipment only in a Restricted Access Area.

2. On the rear side of the chassis is a 3-prong receptacle connector labeled 12-50VDC. Starting from the left side of the terminal block, identify the **negative**, **ground**, and **positive** terminals using either the diagram adjacent to the terminal block or the illustration shown in Figure 9 on page 20.

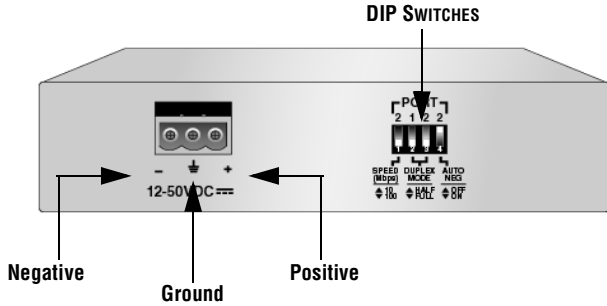

Figure 9 Positive, Ground, and Negative Symbols



Warning

The power input must be provided from SELV source only, per IEC 60950. Do not connect to centralized DC battery bank.

3. Secure the power supply cable in the Restricted Access Area using multiple cable ties to minimize the chance of the connections being disturbed by casual contact with the wiring.



Warning

"Safety Hazard"- Check to see if there are any exposed copper strands coming from the installed wires. When this installation is done correctly there should be no exposed copper wire strands extending from the terminal block. Any exposed wiring can conduct harmful levels of electricity to persons touching the wires. ⚡ 16

4. Plug the power connector to the 12-50VDC receptacle connector in the rear of the converter, as shown in Figure 10.

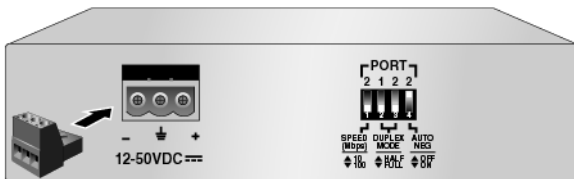

Figure 10 Connecting a Power Connector to the 12-50VDC Version Model

Note

UL recognized wires of 22-gauge minimum should be provided by the installer.

- With a 22-gauge wire-stripping tool, strip the three wires in the tray cable coming from the DC input power source to $8\text{mm} \pm 1\text{mm}$ ($0.31\text{in.} \pm 0.039\text{in.}$), as shown in Figure 11 on page 21.

**Warning**

Do not strip more than the recommended amount of wire. Stripping more than the recommended amount can create a safety hazard by leaving exposed wire on the terminal block after installation. 17

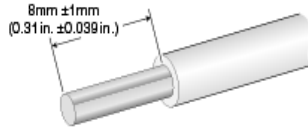

Figure 11 Stripped Wire

- Connect the **ground** wire to the terminal marked with the ground symbol by inserting the wire into power connector that comes with the converter and tightening the connection with a flathead screwdriver, as shown in Figure 12.

**Warning**

When installing this equipment, always ensure that the frame ground connection is installed first and disconnected last. 18

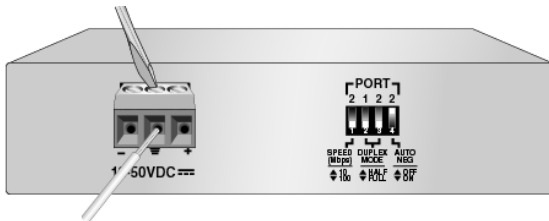

Figure 12 Connecting the Stripped Wire

- Connect the **negative** feed wire to the terminal block marked (-).
- Connect the **positive** feed wire to the terminal block marked (+).

9. Connect the other end of the wires to the terminal block on the AT-PWR237 power adapter.

Note

The terminal block on the AT-PWR237 does not have a connection for the **ground** feed wire.



Warning

"Safety Hazard"- Check to see if there are any exposed copper strands coming from the installed wires. When this installation is done correctly there should be no exposed copper wire strands extending from the terminal block. Any exposed wiring can conduct harmful levels of electricity to persons touching the wires. ⚡ 19

10. With the wires securely connected to both the input power connector in the rear of the unit and the terminal block on the power source, plug the other end of the power source to the power outlet. (Refer to "Technical Specifications" on page 27 for power requirements.)
11. Power ON the end-nodes.
12. Verify that the LNK LEDs for both the fiber optic port and the twisted pair port are green. If either LED is OFF, refer to "Troubleshooting" on page 25 for instructions.

The bridging converter runs a series of self-diagnostic tests. Once the self tests are complete, the converter is ready for normal network operations.

Warranty Registration

When you finish installing the product, you should register your product by completing the enclosed warranty card and sending it in.

Chapter 3

Troubleshooting

Follow the guidelines below to test and troubleshoot the installation in the event a problem occurs.

Note

Whenever the speed and/or duplex mode are changed during or after power ON, power OFF then power back ON the bridging converter to load the new configuration.

If the PWR LED is OFF, do the following:

- If the bridging converter is installed on a desktop, check to be sure that the power adapter is securely connected to a power outlet and that the power adapter cable is securely connected to the back of the bridging converter.
- If the bridging converter is installed in an AT-MCR12 chassis, check that the unit is fully seated in the slot and the retaining screw is securely fastened.
- Verify that the power outlet has power by connecting another device to it.
- Try using another power adapter.

If the LNK LED for the twisted pair port is OFF, do the following:

- Check that the end-node connected to the port is powered ON and is operating properly.
- Check that the twisted pair cable is securely connected to the twisted pair port on the bridging converter and on the end-node.
- Check to be sure that the end-nodes connected to the bridging converter are operating at the same duplex mode.

- ❑ Make sure that the twisted pair cable does not exceed 100 meters (328 feet) and that you are using a Category 3 or better cable for 10Base-T operation or a Category 5 or better cable for 100Base-TX operation.

If the LNK/ACT LED for the fiber optic port is OFF, do the following:

- ❑ Verify that the end-node connected to the port is ON and is operating properly.
- ❑ Check that the fiber optic cable is securely connected to the fiber optic port on the bridging converter and on the end-node.
- ❑ Check to be sure that the end-node connected to the port is operating at 100 Mbps.
- ❑ Check to be sure that the end-nodes connected to the bridging converter are operating at the same duplex mode.
- ❑ Make sure that the cable connected to the bridging converter's receiver port (RX) is connected to the end-node's transmitter port (TX) and that the bridging converter's transmitter port (TX) is connected to the end-node's receiver port (RX).
- ❑ Test the attenuation on the fiber cable to ensure that it does not exceed acceptable values.
- ❑ Verify that you are using the appropriate type of fiber optic cables and that you have not exceeded the maximum operating distances. For the maximum operating distances, refer to Table 1 on page 4 and for the cable types, refer to Table 4 on page 15.
- ❑ Check that the operating specifications of the fiber optic port on the end-node are compatible with the operating specifications of the fiber optic port on the bridging converter. For the fiber optic port specifications, refer to "Fiber Optic Port Specifications" on page 29.

If you are still experiencing problems after testing and troubleshooting the installation, contact Allied Telesyn Technical Support for assistance. Refer to "Contacting Allied Telesyn Technical Support" on page x or visit our web site at **www.alliedtelesyn.com** for support information.

Appendix A

Technical Specifications

Physical

Dimensions: W x D x H
10.5 cm x 9.5 cm x 2.5 cm
(4.12 in x 3.75 in x 1.0 in)

Weight: 294 g (10.4 oz)

Environmental

Maximum Operating Temperature: 0° C to 40° C (32° F to 104° F)

Maximum Storage Temperature: -25° C to 70° C (-13° F to 158° F)

Relative Humidity Storage: 5% to 95% non-condensing

Relative Humidity Operating: 5% to 90% non-condensing

Operating and Storage Altitude: Up to 3,048 meters (10,000 feet)

Electrical Rating

Input Supply Voltage: 12VDC or 12-50VDC

Rated Currents: 0.5A or 0.13A (maximum)

Power Consumption: 6 W (maximum)

Agency Certifications

Safety	Conforms to all standards normally supported by Allied Telesyn products including safety standards UL60950 (cULus), EN60950, EN60825 (TUV) CE Compliant
Standard	IEEE 802.3, IEEE 802.3u
Immunity	Conforms to EN55024 immunity standard
EMI/RFI	Meets all applicable requirements for emissions including but not limited to FCC Part 15 Class B, EN55022 Class B

Fiber Optic Port Specifications

Table 6 through Table 9 list the specifications for the fiber optic port.

Table 6 Fiber Optic Transmitter

Model	Fiber Type ¹ - Connector	Fiber Optic Diameter (microns)	Optical Wavelength	Launch Power (dBm) ²		
				Min.	Avg. ³	Max.
AT-FS238a/1	SMF Simplex - SC	9/125	1310 nm	-15.0	-11.0	-8.0
AT-FS238a/2	SMF Simplex - SC	9/125	1310 nm	-8.0	-5.0	-2.0
AT-FS238b/1	SMF Simplex - SC	9/125	1550 nm	-15.0	-11.0	-8.0
AT-FS238b/2	SMF Simplex - SC	9/125	1550 nm	-8.0	-5.0	-2.0

1. SMF = Single-Mode Fiber
2. Launch Power is measured at one meter from the transmitter.
3. Launch Power (Avg.) is power coupled into a single-mode fiber.

Table 7 Fiber Optic Receiver

Model	Fiber Type ¹ - Connector	Fiber Optic Diameter (microns)	Optical Wavelength	Receiver Sensitivity (dBm)		
				Max.	Avg.	Saturation
AT-FS238a/1	SMF Simplex - SC	9/125	1550 nm	-30.0	n/a	-7.5
AT-FS238a/2	SMF Simplex - SC	9/125	1550 nm	-33.0	n/a	-2.0
AT-FS238b/1	SMF Simplex - SC	9/125	1310 nm	-30.0	n/a	-7.5
AT-FS238b/2	SMF Simplex - SC	9/125	1310 nm	-33.0	n/a	-2.0

1. SMF = Single-Mode Fiber

Table 8 Fiber Optic Datalink

Model	Fiber Type¹	Minimum Power/Link Budget	Minimum Operating Distance²	Maximum Operating Distance³
AT-FS238a/1	9/125 SMF Simplex	6.0 dB	0	15 km (9.4 mi)
AT-FS238a/2	9/125 SMF Simplex	16.0 dB	0	40 km (25 mi)
AT-FS238b/1	9/125 SMF Simplex	6.0 dB	0	15 km (9.4 mi)
AT-FS238b/2	9/125 SMF Simplex	16.0 dB	0	40 km (25 mi)

1. SMF = Single-Mode Fiber
2. The recommended minimum range is stated in all cases where the maximum transmitter output power exceeds the receivers saturation level. This is to prevent blinding or burning out of the optical receiver on the far-end node.
3. Distance is calculated based on ideal situations without any other loss factor.

Table 9 Fiber Optic Loss Specification (Benchmark)

Fiber Type¹ - Connector	Fiber Optic Diameter	Optical Wavelength	Typical Loss Factor	Bandwidth
SMF Simplex - SC	9/125 microns	1310 nm	0.40 dB/km	N/A

1. SMF = Single-Mode Fiber

RJ-45 Pinout Assignments

Figure 13 shows the pin assignments of the RJ-45 connector.

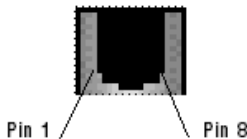

Figure 13 RJ-45 Pin Assignments

Table 10 lists the 10Base-T/100Base-TX connector pins and their signals when the port is operating in either MDI or MDI-X configuration.

Table 10 RJ-45 Pinouts

MDI-X	Signal	MDI	Signal
1	RX+	1	TX+
2	RX-	2	TX-
3	TX+	3	RX+
4	-	4	-
5	-	5	-
6	TX-	6	RX-
7	-	7	-
8	-	8	-

Appendix B

Translated Safety and Emission Information

Important: This appendix contains multiple-language translations for the safety statements in this guide.

Wichtig: Dieser Anhang enthält Übersetzungen der in diesem Handbuch enthaltenen Sicherheitshinweise in mehreren Sprachen.

Vigtigt: Dette tillæg indeholder oversættelser i flere sprog af sikkerhedsadvarselene i denne håndbog.

Belangrijk: Deze appendix bevat vertalingen in meerdere talen van de veiligheidsopmerkingen in deze gids.

Important: Cette annexe contient la traduction en plusieurs langues des instructions de sécurité figurant dans ce guide.

Tärkeää: Tämä liite sisältää tässä oppaassa esiintyvät turvaohjeet usealla kielellä.

Importante: questa appendice contiene traduzioni in più lingue degli avvisi di sicurezza di questa guida.

Viktig: Dette tillegget inneholder oversettelser til flere språk av sikkerhetsinformasjonen i denne veiledningen.

Importante: Este anexo contém traduções em vários idiomas das advertências de segurança neste guia.

Importante: Este apéndice contiene traducciones en múltiples idiomas de los mensajes de seguridad incluidos en esta guía.

Obs! Denna bilaga innehåller flerspråkiga översättningar av säkerhetsmeddelandena i denna handledning.

Standards: This product meets the following standards:

U.S. Federal Communications Commission

Declaration Of Conformity

Manufacturer Name:	Allied Telesyn, Inc.
Manufacturer Address:	960 Stewart Drive, Suite B Sunnyvale, CA 94085, USA
Manufacturer Telephone:	408-730-0950
Declares that the product:	Bridging Converter
Model Numbers:	AT-FS238a/1, AT-FS238b/1, AT-FS238a/2, AT-FS238b/2

This product complies with FCC Part 15B, Class B Limits:

This device complies with part 15 of the FCC Rules. Operation is subject to the following two conditions: (1) This device must not cause harmful interference, and (2) this device must accept any interference received, including interference that may cause undesired operation.

Radiated Energy

Note: This equipment has been tested and found to comply with the limits for a Class B digital device pursuant to Part 15 of FCC Rules. These limits are designed to provide reasonable protection against harmful interference in a residential installation. This equipment generates, uses and can radiate radio frequency energy and, if not installed and used in accordance with instructions, may cause harmful interference to radio or television reception, which can be determined by turning the equipment off and on. The user is encouraged to try to correct the interference by one or more of the following measures:







- Reorient or relocate the receiving antenna.
- Increase the separation between the equipment and the receiver.
- Connect the equipment into an outlet on a circuit different from that to which the receiver is connected.
- Consult the dealer or an experienced radio/TV technician for help.



Changes and modifications not expressly approved by the manufacturer or registrant of this equipment can void your authority to operate this equipment under Federal Communications Commission rules.

Industry Canada



This Class B digital apparatus meets all requirements of the Canadian Interference-Causing Equipment Regulations.

Cet appareil numérique de la classe B respecte toutes les exigences du Règlement sur le matériel brouilleur du Canada.





- 🌀 1 RFI Emission EN55022 Class B
- 🌀 2  **Warning:** In a domestic environment this product may cause radio interference in which case the user may be required to take adequate measures.
- 🌀 3 Immunity EN55024
- 🌀 4 **Warning:** This product requires shielded cables to comply with emission and immunity standards. If it is used with unshielded cables, the user may be required to take measures to correct the interference problem at their own expense.
- 🌀 5 Electrical Safety EN60950, UL60950
- 🌀 6  Laser EN60825
- 🌀 7 **Warning** Class 1 Laser product.
- 🌀 8 **Warning** Do not stare into the Laser beam.
At time of installation, the Fiber Optic Lasers comply with FDA Radiation Performance Standard 21CFR Subchapter J, applicable at date of manufacture.
- 🌀 9 This is a “Class 1 LED Product” (AT-FS237s13/1)
Safety
- 🌀 10  **Lightning Danger**
Danger: Do not work on equipment or cables during periods of lightning activity.
- 🌀 11 Do not block air vents.
- 🌀 12 Power to the hub must be sourced only from the adapter.
USA/Canada
Use a UL Listed/CSA Certified AC adapter of DC 12V/15V, 500mA.
Europe - EU
Use TÜV licensed AC adapter of DC 12V/15V, 500mA.
UK
Use a UK Safety Approved AC adapter of DC 12V/15V, minimum 500mA.
- 🌀 13 **Operating Temperature:** This product is designed for a maximum ambient temperature of 40 degrees C.
- 🌀 14 **All Countries:** Install product in accordance with local and National Electrical Codes.
- 🌀 15  **WARNING:** Do not strip more than the recommended amount of wire. Stripping more than the recommended amount can create a safety hazard by leaving exposed wire on the terminal block after installation.
- 🌀 16  **CAUTION:** “Safety Hazard” Check to see if there are any exposed copper strands coming from the installed wire. When this installation is done correctly there should be no exposed copper wire strands extending from the terminal block. Any exposed wiring can conduct harmful levels of electricity to persons touching the wires.
- 🌀 17  **WARNING:** Do not strip more than the recommended amount of wire. Stripping more than the recommended amount can create a safety hazard by leaving exposed wire on the terminal block after installation.
- 🌀 18  **WARNING:** When installing this equipment, always ensure that the frame ground connection is installed first and disconnected last.

-  **19**  **CAUTION:** “Safety Hazard” Check to see if there are any exposed copper strands coming from the installed wire. When this installation is done correctly there should be no exposed copper wire strands extending from the terminal block. Any exposed wiring can conduct harmful levels of electricity to persons touching the wires.

Normen: Dieses Produkt erfüllt die Anforderungen der nachfolgenden Normen.







- 🌀 1 Hochfrequenzstörung EN55022 Klasse B
- 🌀 2  **Warnung:** Bei Verwendung zu Hause kann dieses Produkt Funkstörungen hervorrufen. In diesem Fall müßte der Anwender angemessene Gegenmaßnahmen ergreifen.
- 🌀 3 Störsicherheit EN55024
- 🌀 4 **Achtung:** Für dieses Produkt sind abgeschirmte Kabel erforderlich, damit den Richtlinien für Emission und Interferenzschutz entsprochen wird. Falls das Produkt mit nicht abgeschirmten Kabeln verwendet wird, können weitergehende Maßnahmen für die Korrektur von Interferenzproblemen auf Kosten des Benutzers notwendig werden.
- 🌀 5 Elektrische Sicherheit EN60950, UL60950
- 🌀 6  **Laser** EN60825
- 🌀 7 **Warnung** Laserprodukt der Klasse 1.
- 🌀 8 **Warnung** Nicht direkt in den Strahl blicken.
- 🌀 9 Das ist ein "LED Produkt der Klasse 1"



Sicherheit

- 🌀 10  **Gefahr Durch Blitzschla**
Gefahr: Keine Arbeiten am Gerät oder an den Kabeln während eines Gewitters ausführen
- 🌀 11 Entlüftungsöffnungen nicht versperren.
- 🌀 12 Der Buchse darf nur aus dem Adapter Strom zugeführt werden.
Europe - EU
Gebrauchen Sie einen von TÜV zugelassenen Wechselstromadapter für Gleichstrom 12V/15V, 500 mA.
- 🌀 13 **Betriebstemperatur**
Dieses Produkt wurde für den Betrieb in einer Umgebungstemperatur von nicht mehr als 40° C entworfen.
- 🌀 14 **Alle Länder:** Installation muß örtlichen und nationalen elektrischen Vorschriften entsprechen.
- 🌀 15  **WARNUNG:** Ziehen Sie nicht mehr als die empfohlene Drahtlänge ab. Wird mehr als die empfohlene Länge abisoliert, stellt dies ein Sicherheitsrisiko dar, da auf dem Anschlußklemmblock nach der Installation möglicherweise freiliegende Drähte verbleiben.
- 🌀 16  **VORSICHT:** "Sicherheitsrisiko" Prüfen Sie, daß aus dem installierten Draht keine freiliegenden Kupferlitzen herausragen. Bei korrekter Installation sollten aus dem Anschlußklemmblock keine freiliegenden Kupferlitzen vorstehen. Freiliegende Kabel führen genug Spannung, um Personen zu gefährden, die diese Drähte berühren.
- 🌀 17  **WARNUNG:** Ziehen Sie nicht mehr als die empfohlene Drahtlänge ab. Wird mehr als die empfohlene Länge abisoliert, stellt dies ein Sicherheitsrisiko dar, da auf dem Anschlußklemmblock nach der Installation möglicherweise freiliegende Drähte verbleiben.







- ⚡ **18** ■ **WARNUNG:** Bei der Installation dieser Einrichtung ist stets sicherzustellen, daß der Masseanschluß jeweils zuerst installiert und zuletzt getrennt wird.
- ⚡ **19** ■ **VORSICHT:** "Sicherheitsrisiko" Prüfen Sie, daß aus dem installierten Draht keine freiliegenden Kupferlitzen herausragen. Bei korrekter Installation sollten aus dem Anschlußklemmblock keine freiliegenden Kupferlitzen vorstehen. Freiliegende Kabel führen genug Spannung, um Personen zu gefährden, die diese Drähte berühren.



Standarder: Dette produkt tilfredsstiller de følgende standarder.

- 1 Radiofrekvens forstyrrelsesemission EN55022 Klasse B
 - 2  **Advarsel:** I et hjemligt miljø kunne dette produkt forårsage radio forstyrrelse. Bliver det tilfældet, påkræves brugeren muligvis at tage tilstrækkelige foranstaltninger.
 - 3 Immunitet EN55024
 - 4 **Advarsel:** Dette produkt skal bruges med afskærmede kabler for at overholde bestemmelserne vedrørende udstråling og støjimmunitet. Hvis det bruges med uafskærmede kabler, kan det blive påkrævet af brugeren at korrigere interferensproblemer for egen regning.
 - 5 Elektrisk sikkerhed. EN60950, UL60950
 - 6  Laser EN60825
 - 7 **Advarsel** Laserprodukt av klasse 1.
 - 8 **Advarsel** Stirr ikke på strålen.
 - 9 Dette er et "Produkt under Klasse 1 LED"
- Sikkerhed**
- 10  **Fare Under Uvejr**
Fare: Undlad at arbejde på udstyr eller kabler i perioder med lynaktivitet.
 - 11 Ventilationsåbningerne må ikke blokeres.
 - 12 Strømforsyningen til apparatet må udelukkende tages fra tilpasningstransformatoren.
- Europe - EU**
Brug kun TÜV godkendt vekselstrømstransformator på 12V/15V jævnstrøm, 500 mA.
- 13 **Betjeningstemperatur**
Dette apparat er konstrueret til en omgivende temperatur på maksimum 40 grader C.
 - 14 **Alle Lande:** Installation af produktet skal ske i overensstemmelse med lokal og national lovgivning for elektriske installationer.
 - 15  **ADVARSEL:** Man bør ikke afisolere mere af ledningerne end anvist, for så kan sådanne blanke ledninger udgøre et faremoment efter montering på klemmerækken.
 - 16  **FORSIKTIG:** "Fare" Se omhyggeligt efter om der stikker blanke kobbertråde ud fra klemmeforbindelserne. Ved korrekt montering er det ikke tilfældet. Enhver afisoleret leder kan lede farlig strømstyrke til personer, som kommer til at røre ved dem.
 - 17  **ADVARSEL:** Man bør ikke afisolere mere af ledningerne end anvist, for så kan sådanne blanke ledninger udgøre et faremoment efter montering på klemmerækken.
 - 18  **ADVARSEL:** Ved installering af dette udstyr skal støjjord altid forbindes først og aftages sidst.







-  **19**  **FORSIKTIG:** "Fare" Se omhyggeligt efter om der stikker blanke kobbertråde ud fra klemmeforbindelserne. Ved korrekt montering er det ikke tilfældet. Enhver afisoleret leder kan lede farlig strømstyrke til personer, som kommer til at røre ved dem.



Eisen: Dit product voldoet aan de volgende eisen.

- 1 RFI Emissie EN55022 Klasse B
 - 2  **Waarschuwing:** Binnenshuis kan dit product radiostoring veroorzaken, in welk geval de gebruiker verplicht kan worden om gepaste maatregelen te nemen.
 - 3 Immuniteit EN55024
 - 4 **Waarschuwing:** Om te voldoen aan de emissie- en immuniteitsnormen dient dit apparaat te zijn voorzien van afgeschermd kabels. Als het met niet-afgeschermd kabels wordt gebruikt, kan het zijn dat de gebruiker maatregelen moet treffen om interferentieproblemen voor eigen rekening op te lossen.
 - 5 Elektrische Veiligheid EN60950, UL60950
 - 6  Laser EN60825
 - 7 **Waarschuwing** Klasse-1 laser produkt.
 - 8 **Waarschuwing** Neit in de straal staren.
 - 9 Dit is een “Klasse 1 LED-produkt”
- Veiligheid**
- 10  **Gevaar Voor Blikseminslag**
Gevaar: Niet aan toestellen of kabels werken bij bliksem.
 - 11 Ventilatiegaten niet blokkeren.
 - 12 Stroom mag alleen via de adapter naar het apparaat toegevoerd worden.
- Europe - EU**
Gebruik een door TÜV gekeurde wisselstroomadapter van 12V/15V gelijkstroom, 500 milliampères.
- 13 **Bedrijfstemperatuur**
De omgevingstemperatuur voor dit produkt mag niet meer bedragen dan 40 graden Celsius.
 - 14 **Alle Landen:** het toestel installeren overeenkomstig de lokale en nationale elektrische voorschriften.
 - 15  **WAARSCHUWING:** Verwijder niet meer dan de aanbevolen hoeveelheid isolatiemateriaal. Als u meer dan de aanbevolen hoeveelheid verwijdert, kan dit een veiligheidsrisico veroorzaken doordat draden bloot blijven liggen na aansluiting op het blok.
 - 16  **LET OP:** “Veiligheidsrisico” Controleer of er bij de aangesloten bedrading geen koper blootligt. Als de installatie juist is uitgevoerd, is er bij het aansluitblok geen koperdraad zichtbaar. Blootliggende bedrading kan schadelijke elektriciteitsniveaus geleiden naar personen die met de draden in aanraking komen.
 - 17  **WAARSCHUWING:** Verwijder niet meer dan de aanbevolen hoeveelheid isolatiemateriaal. Als u meer dan de aanbevolen hoeveelheid verwijdert, kan dit een veiligheidsrisico veroorzaken doordat draden bloot blijven liggen na aansluiting op het blok.
 - 18  **WAARSCHUWING:** Zorg er tijdens installatie van de apparatuur altijd voor dat de aardeaansluiting van het frame als eerste wordt geplaatst en als laatste wordt losgemaakt.



-  **19**  **LET OP:** “Veiligheidsrisico” Controleer of er bij de aangesloten bedrading geen koper blootligt. Als de installatie juist is uitgevoerd, is er bij het aansluitblok geen koperdraad zichtbaar. Blootliggende bedrading kan schadelijke elektriciteitsniveaus geleiden naar personen die met de draden in aanraking komen.

Normes: Ce produit est conforme aux normes de suivantes.

- 1 Emission d'interférences radioélectriques EN55022 Classe B
 - 2  **Mise En Garde:** Dans un environnement domestique, ce produit peut provoquer des interférences radioélectriques. Auquel cas, l'utilisateur devra prendre les mesures adéquates.
 - 3 Immunité EN55024
 - 4 **Avertissement :** Il faut utiliser des câbles blindés pour ce produit afin de respecter les normes d'émission et d'immunité. Si l'utilisateur choisit d'utiliser des câbles non blindés, il sera peut-être contraint de prendre les mesures nécessaires pour corriger les problèmes d'interférences, ainsi que d'assumer le coût correspondant.
 - 5 Sécurité électrique EN60950, UL60950
 - 6  Laser EN60825
 - 7 **Attention** Produit laser di classe 1.
 - 8 **Attention** Ne pas fixer le faisceau des yeux.
 - 9 Ce matériel est un "Produit à diode électroluminescente de Classe 1"
- Sécurité**
- 10  **Danger De Foudre**
Danger: Ne pas manier le matériel ou les câbles lors d'activité orageuse.
 - 11 Ne pas bloquer les fentes d'aération.
 - 12 L'alimentation du concentrateur doit être uniquement fournie par l'adaptateur.
Europe - EU
Utiliser un adaptateur secteur conforme TÜV de 12V/15V, 500 mA en courant continu.
 - 13 **Température De Fonctionnement**
Ce matériel est capable de tolérer une température ambiante maximum de 40 degrés Celsius.
 - 14 **Pour Tous Pays:** Installer le matériel conformément aux normes électriques nationales et locales.
 - 15  **AVERTISSEMENT:** Ne coupez pas une quantité de câble supérieure à celle qui est recommandée. Cela pourrait constituer un risque de sécurité en laissant du câblage à nu sur le bornier après l'installation.
 - 16  **ATTENTION:** "Risque de sécurité" Vérifiez qu'aucun fil de cuivre dénudé ne sort du câble installé. Lorsque cette installation est effectuée correctement, aucun fil de cuivre ne devrait dépasser du bornier. Tout câblage dénudé peut être conducteur de tensions dangereuses pour les personnes touchant les câbles.
 - 17  **AVERTISSEMENT:** Ne coupez pas une quantité de câble supérieure à celle qui est recommandée. Cela pourrait constituer un risque de sécurité en laissant du câblage à nu sur le bornier après l'installation.
 - 18  **AVERTISSEMENT:** Lors de l'installation de cet équipement, vérifiez toujours que la connexion de terre du châssis est installée en premier et débranchée en dernier.

-  **19**  **ATTENTION: “Risque de sécurité”** Vérifiez qu’aucun fil de cuivre dénudé ne sort du câble installé. Lorsque cette installation est effectuée correctement, aucun fil de cuivre ne devrait dépasser du bornier. Tout câblage dénudé peut être conducteur de tensions dangereuses pour les personnes touchant les câbles.

Standardit: Tämä tuote on seuraavien standardien mukainen.





- 1 Radioaaltojen häirintä EN55022 Luokka B
- 2  **Varoitus:** Kotiolosuhteissa tämä laite voi aiheuttaa radioaaltojen häiriötä, missä tapauksessa laitteen käyttäjän on mahdollisesti ryhdyttävä tarpeellisiin toimenpiteisiin.
- 3 Kestävyys EN55024
- 4 **Varoitus:** Tämä tuote vaatii suojattuja kaapeleita toimiakseen emissio- ja häiriönsietostandardien mukaisesti. Jos tuotetta käytetään ilman suojattuja kaapeleita, käyttäjä voi joutua korjaamaan häirinnän aiheuttaman ongelman omalla kustannuksellaan.
- 5 Sähköturvallisuus EN60950, UL60950
- 6  Laser EN60825
- 7 **Varoitus** Luokan 1 Lasertuote.
- 8 **Variotus** Älä katso säteeseen.
- 9 Tämä on "Ensimmäisen luokan valodiodituote"



Turvallisuus

- 10  **Salamaniskuvaara**
Engenvaara: Älä työskentele laitteiden tai kaapeleiden kanssa salamoinnin aikana.
- 11 Älä tuki ilmareikiä.
- 12 Tähtipisteeseen (hub) syötettävän virran pitää tulla ainoastaan sovittimesta.



Europe - EU

Käytä TÜV-lisenssillä valmistettua verkkosovitinta, jonka tasajännitteen nimellisarvot ovat DC 12V/15V, 500 mA (milliampeeria).





- 13 **Käyttölämpötila**
Tämä tuote on suunniteltu ympäröivän ilman maksimilämpötilalle 40° C.
- 14 **Kaikki Maat:** Asenna tuote paikallisten ja kansallisten sähköturvallisuusmääräysten mukaisesti.
- 15  **VAROITUS:**Älä poista johtimesta päällystettä enempää kuin on suositeltu. Päällysteen poistaminen suositusta pidemmältä matkalta voi aiheuttaa turvallisuusrisikin, sillä riviliittimeen jää asennuksen jälkeen paljaita johtimia.
- 16  **HUOMIO:** Turvallisuusriski Tarkista, ettei asennetusta johtimesta näy paljaita kuparisäikeitä. Kun asennus suoritetaan oikein, riviliittimestä ei pitäisi näkyä paljaita kuparijohdinsäikeitä. Paljaat johtimet voivat aiheuttaa sähköiskuvaaran, jos niihin kosketaan.
- 17  **VAROITUS:**Älä poista johtimesta päällystettä enempää kuin on suositeltu. Päällysteen poistaminen suositusta pidemmältä matkalta voi aiheuttaa turvallisuusrisikin, sillä riviliittimeen jää asennuksen jälkeen paljaita johtimia.
- 18  **VAROITUS:**Kun asennat tätä laitetta, varmista aina, että runkomaadoitettu liitin kytketään ensin ja irrotetaan viimeiseksi.

-  **19**  **HUOMIO:** Turvallisuusriski Tarkista, ettei asennetusta johtimesta näy paljaita kuparisäikeitä. Kun asennus suoritetaan oikein, riviliittimestä ei pitäisi näkyä paljaita kuparijohdinsäikeitä. Paljaat johtimet voivat aiheuttaa sähköiskuvaaran, jos niihin kosketaan.

Standard: Questo prodotto è conforme ai seguenti standard.







- 1 Emissione RFI (interferenza di radiofrequenza) EN55022 Classe B
- 2  **Avvertenza:** in ambiente domestico questo prodotto potrebbe causare radio interferenza. In questo caso potrebbe richiedersi all'utente di prendere gli adeguati provvedimenti.
- 3 Immunità EN55024
- 4 **Avvertenza:** questo prodotto, se utilizzato con cavi schermati, è conforme alle norme sulle emissioni e sull'immunità. In caso di uso senza cavi schermati, l'utente può dover adottare a proprie spese misure correttive contro le interferenze.
- 5 Sicurezza elettrica EN60950, UL60950
- 6  Laser EN60825
- 7 **Avvertenza** Prodotto laser di Classe 1.
- 8 **Avvertenza** Non fissare il raggio con gli occhi.
- 9 Questo è un "Prodotto con LED di Classe 1"

Norme Di Sicurezza

- 10  **Pericolo Di Fulmini**
Pericolo: Non lavorare sul dispositivo o sui cavi durante precipitazioni temporalesche.
- 11 Non ostruire le prese d'aria.
- 12 Questo dispositivo deve essere alimentato solo mediante l'adattatore.
Europe - EU
Utilizzare l'adattatore per c.a. da 12V/15V c.c. e 500 mA conforme alla normativa TÜV.
- 13 **Temperatura Di Funzionamento**
Questo prodotto è concepito per una temperatura ambientale massima di 40 gradi centigradi.
- 14 **Tutti I Paesi:** installare il prodotto in conformità delle vigenti normative elettriche nazionali.
- 15  **AVVERTENZA:** Per evitare i possibili pericoli associati all'esposizione dei fili sulla morsettiera dopo l'installazione, non rimuovere l'isolamento oltre le misure specificate.
- 16  **ATTENZIONE:** "Pericolo!" Controllare che il filo installato non abbia trefoli in rame esposti. Se l'installazione è stata effettuata in modo corretto, non vi deve protrudere dalla morsettiera alcun trefolo in rame esposto. In caso di contatto, un filo esposto può condurre livelli di elettricità pericolosi a quanti lo tocchino.
- 17  **AVVERTENZA:** Per evitare i possibili pericoli associati all'esposizione dei fili sulla morsettiera dopo l'installazione, non rimuovere l'isolamento oltre le misure specificate.
- 18  **AVVERTENZA:** Quando si installa questo apparecchio, accertarsi sempre che il collegamento a massa del telaio sia sempre il primo ad essere effettuato e l'ultimo ad essere scollegato.



-  **19** ■ **ATTENZIONE:** “Pericolo!” Controllare che il filo installato non abbia trefoli in rame esposti. Se l’installazione è stata effettuata in modo corretto, non vi deve protrudere dalla morsettiere alcun trefolo in rame esposto. In caso di contatto, un filo esposto può condurre livelli di elettricità pericolosi a quanto lo tocchino.

Sikkerhetsnormer: Dette produktet tilfredsstiller følgende sikkerhetsnormer.





- 1 RFI stråling EN55022 Klasse B
 - 2  **Advarsel:** Hvis dette produktet benyttes til privat bruk, kan produktet forårsake radioforstyrrelse. Hvis dette skjer, må brukeren ta de nødvendige forholdsregler.
 - 3 Immunitet EN55024
 - 4 **Advarsel:** Dette produktet må brukes med vernede kabler for å tilfredsstille emisjons- og fritakelsesstandarder. Dersom produktet brukes med uvernede kabler, må brukeren muligens rette forstyrrelsesproblemene for egen regning.
 - 5 Elektrisk sikkerhet EN60950, UL60950
 - 6  Laser EN60825
 - 7 **Advarsel** Laserprodukt av klasse 1.
 - 8 **Advarsal** Stirr ikke på strålen.
 - 9 Dette er et "Klasse 1 LED produkt"
- Sikkerhet**
- 10  **Fare For Lynnedslag**
Fare: Arbeid ikke på utstyr eller kabler i tordenvær.
 - 11 Blokker Ikke Luftventilene
 - 12 All strømtilførsel må komme fra adapteren.
- Europe - EU**
Benytt TÜV-godkjent AC-adapter på 12V/15V DC, 500mA (millismpere)
- 13 **Driftstemperatur**
Dette produktet er konstruert for bruk i maksimum romtemperatur på 40 grader celsius.
 - 14 **Alle Land:** Produktet må installeres i samsvar med de lokale og nasjonale elektriske koder.
 - 15  **ADVARSEL:** Du skal ikke avisolere mer av ledningen enn det som er anbefalt. Dersom du avisolerer mer enn det som er anbefalt, kan dette forårsake en sikkerhetsfare, ettersom det vil finnes uisolert ledning på rekkeklemmen etter montering.
 - 16  **FORSIKTIG:** "Sikkerhetsfare" Kontroller om uisolerte koppertråder stikker ut av den monterte ledningen. Hvis monteringen er riktig utført, skal det ikke finnes uisolerte kobbertråder som stikker ut fra rekkeklemmen. Uisolerte ledninger kan lede skadelige mengder strøm til personer som berører ledningene.
 - 17  **ADVARSEL:** Du skal ikke avisolere mer av ledningen enn det som er anbefalt. Dersom du avisolerer mer enn det som er anbefalt, kan dette forårsake en sikkerhetsfare, ettersom det vil finnes uisolert ledning på rekkeklemmen etter montering.
 - 18  **ADVARSEL:** Når du monterer dette utstyret, skal du alltid passe på at forbindelsen til rammejordingen monteres først og koples fra sist.



-  **19** ■ **FORSIKTIG:** "Sikkerhetsfare" Kontroller om uisolerte koppertråder stikker ut av den monterte ledningen. Hvis monteringen er riktig utført, skal det ikke finnes uisolerte kobbertråder som stikker ut fra rekkeklemmen. Uisolerte ledninger kan lede skadelige mengder strøm til personer som berører ledningene.

Padrões: Este produto atende aos seguintes padrões.



- 1 Emissão De Interferência De Radiofrequência EN55022 Classe B
- 2  **Aviso:** Num ambiente doméstico este produto pode causar interferência na radiorrecepção e, neste caso, pode ser necessário que o utente tome as medidas adequadas.
- 3 Imunidade EN55024
- 4 **Advertência:** Este produto requer a utilização de cabos blindados para cumprimento dos standards de limites de emissão e imunidade. Se o produto for utilizado com cabos não blindados, o utilizador poderá necessitar de tomar medidas para correcção de problemas de interferência, por sua própria conta.
- 5 Segurança Eléctrica EN60950, UL60950
- 6  Laser EN60825
- 7 **Aviso** Produto laser de classe 1.
- 8 **Aviso** Não olhe fixamente para o raio.
- 9 Este é um “Produto Classe 1 LED”

Segurança

- 10  **Perigo De Choque Causado Por Raio**
Perigo: Não trabalhe no equipamento ou nos cabos durante períodos suscetíveis a quedas de raio.
 - 11 Não Bloqueie As Aberturas De Ventilação
 - 12 Use somente o adaptador fornecido para alimentação elétrica do hub.
- Europe - EU**
Use um adaptador de corrente alternada com saída DC de 12V/15V e 500mA em conformidade com as especificações da TÜV.
- 13 **Temperatura De Funcionamento**
Este produto foi projetado para uma temperatura ambiente máxima de 40 graus centígrados.
 - 14 **Todos Os Países:** Instale o produto de acordo com as normas nacionais e locais para instalações elétricas.
 - 15  **AVISO:** Não corte mais fio do que recomendado. Cortar mais do que o recomendado pode ser perigoso, por deixar fio exposto no terminal depois da instalação.
 - 16  **ATENÇÃO:** “Perigo” Verifique se há algum fio de cobre exposto a sair do fio instalado. Quando esta instalação é feita correctamente não deve haver qualquer fio de cobre exposto a sair do terminal. Qualquer fio exposto pode conduzir níveis perigosos de electricidade para a pessoa que toque nos fios.
 - 17  **AVISO:** Não corte mais fio do que recomendado. Cortar mais do que o recomendado pode ser perigoso, por deixar fio exposto no terminal depois da instalação.
 - 18  **AVISO:** Ao ligar este equipamento, instale sempre primeiro a ligação à terra e desligue-a sempre em último.

-  **19**  **ATENÇÃO:** “Perigo” Verifique se há algum fio de cobre exposto a sair do fio instalado. Quando esta instalação é feita correctamente não deve haver qualquer fio de cobre exposto a sair do terminal. Qualquer fio exposto pode conduzir níveis perigosos de electricidade para a pessoa que toque nos fios.

Estándares: Este producto cumple con los siguientes estándares.





- 1 Emisión RFI EN55022 Clase B
- 2  **Advertencia:** en un entorno doméstico, este producto puede causar radiointerferencias, en cuyo caso, puede requerirse del usuario que tome las medidas que sean convenientes al respecto.
- 3 Inmunidad EN55024
- 4 **Advertencia:** Este producto exige cables protectores para ajustarse a las normas de emisión e inmunidad. Si se utiliza con cables sin protección, el usuario tendrá que correr con los gastos por las medidas a tomar en caso de problemas de interferencias.
- 5 Seguridad eléctrica EN60950, UL60950
- 6  Laser EN60825
- 7 **¡Advertencia!** Producto láser Clase 1.
- 8 **¡Advertencia!** No mirat fijamente el haz.
- 9 Este es un “Producto de diodo luminiscente (LED) Clase 1”

Seguridad

- 10  **Peligro De Rayos**
Eligro: No realice ningun tipo de trabajo o conexion en los equipos o en los cables durante tormentas electricas.
- 11 No bloquee las aberturas para ventilacion.
- 12 La energía para el dispositivo central o "hub" debe provenir únicamente del adaptador.



Europe - EU

Utilizar un adaptador de corriente alterna autorizado TÜV de 12V/15V de corriente continua y 500 miliamperios.







- 13 **Temperatura Requerida Para La Operación**
Este producto está diseñado para una temperatura ambiental máxima de 40 grados C.
- 14 **Para Todos Los Países:** Monte el producto de acuerdo con los Códigos Eléctricos locales y nacionales.
- 15  **ADVERTENCIA:** No pele el cable más de la cantidad recomendada, ya que si después de instalar el bloque terminal quedan cables pelados, habrá riesgos de seguridad.
- 16  **CUIDADO:** “Riesgo de seguridad” Cerciórese de que no haya hilos de cobre pelados que salgan del alambre instalado. Cuando dicha instalación se realiza correctamente, los hilos de cobre pelados no deben salir del bloque terminal. Todo alambre pelado puede conducir niveles de electricidad nocivos a la persona que lo toca.
- 17  **ADVERTENCIA:** No pele el cable más de la cantidad recomendada, ya que si después de instalar el bloque terminal quedan cables pelados, habrá riesgos de seguridad.
- 18  **ADVERTENCIA:** Cuando instale dicho equipo, asegúrese siempre de que el bastidor se conecte a tierra primero y se desconecte por último.

-  **19** ■ **CUIDADO:** “Riesgo de seguridad” Cerciórese de que no haya hilos de cobre pelados que salgan del alambre instalado. Cuando dicha instalación se realiza correctamente, los hilos de cobre pelados no deben salir del bloque terminal. Todo alambre pelado puede conducir niveles de electricidad nocivos a la persona que lo toca.

Standarder: Denna produkt uppfyller följande standarder.

- ☞ 1 Radiostörning EN55022 Klass B
- ☞ 2  **Varning:** Denna produkt kan ge upphov till radiostörningar i hemmet, vilket kan tvinga användaren till att vidta erforderliga åtgärder.
- ☞ 3 Immunitet EN55024
- ☞ 4 **Varning!** Denna produkt kräver skärmade kablar för att uppfylla standardkraven för emission och immunitet. Om den används med oskärmade kablar kan användaren vara tvungen att vidta åtgärder på egen bekostnad för att åtgärda störningsproblemet.
- ☞ 5 Elsäkerhet EN60950, UL60950
- ☞ 6  Laser EN60825
- ☞ 7 **Varning!** Laserprodukt av klass 1.
- ☞ 8 **Varning!** Laserstrålning när enheten är öppen.
- ☞ 9 Detta är en "Klass 1 lysdiodprodukt"

Säkerhet

- ☞ 10  **Fara För Blixtnedslag**
Fara: Arbeta ej på utrustningen eller kablarna vid åskväder.
 - ☞ 11 Blockera Inte Luftventilerna.
 - ☞ 12 Endast anslutningsenheten får vara kraftkälla till centralen.
- Europe - EU**
Använd en växelströmsanslutningsenhet licensierad av TÜV. Likström 12V/15V, 500mA.
- ☞ 13 **Driftstemperatur**
Denna produkt är konstruerad för rumstemperatur ej överstigande 40 grader Celsius.
 - ☞ 14 **Alla Länder:** Installera produkten i enlighet med lokala och statliga bestämmelser för elektrisk utrustning.
 - ☞ 15  **WARNING:** Skala inte av mer isolering än vad som anges ovan. Skalas för mycket isolering av kan fara uppstå om oskyddad tråd vidröras på anslutningsplinten efter anslutningen.
 - ☞ 16  **OBS! FARA!** Kontrollera om små koppartrådar sticker ut ifrån den anslutna tråden. Om anslutningen utförts riktigt sticker inga trådar ut från anslutningsplinten. Oisolerade trådar kan överföra skadlig elektricitet till person som vidrör trådarna.
 - ☞ 17  **WARNING:** Skala inte av mer isolering än vad som anges ovan. Skalas för mycket isolering av kan fara uppstå om oskyddad tråd vidröras på anslutningsplinten efter anslutningen.
 - ☞ 18  **WARNING:** Vid anslutning av denna utrustning skall man alltid se till att jordtråden ansluts först och lossas sist.
 - ☞ 19  **OBS! FARA!** Kontrollera om små koppartrådar sticker ut ifrån den anslutna tråden. Om anslutningen utförts riktigt sticker inga trådar ut från anslutningsplinten. Oisolerade trådar kan överföra skadlig elektricitet till person som vidrör trådarna.

